

ARCHITECTURAL & ENGINEERING SPECIFICATION

Sundara® Tide Triple basin lavatory system manufactured by Zurn Industries. Lavatory shall be mounted at standard height to conform with ANSI, UFAS, TAS and ADA Accessibility Standards. Counter and integral basin to be constructed of Sundara® solid surface pure acrylic resin with aluminum trihydrate and other additives and conform to CSA B45.5/ IAPMO Z124 and IAPMO IGC 156 standards. Shroud enclosure is constructed of satin finished type 304, 18 gage stainless steel designed for easy access with vandal resistant hardware. Lavatory is furnished complete with 0.5 gpm spray aerator faucet (specify model in sensor or manual, other gpm outlet also available) and optional liquid or foam soap dispenser (specify model), 1/2" quarter turn supply stops, 3/8" flexible supply risers, chrome 1 1/2" tail piece and chrome 1 1/2" p-trap for complete system operation.

PRODUCT FEATURES

- Sundara® engineered solid surface
- Available in multiple colors
- Matched soap and faucet options
- Stainless steel ADA compliant shroud, vandal resistant and easy to install
- Non-splash basin design
- Left or right side integrated soap hole
- Zurn One orders include all required components for installation and Z8700 series P trap along with Z8802 series supply stops with 16" flexible supplies
- Provided with chrome finish faucet, soap dispenser and grid drain. Select faucets available in alternate finishes
- Provided with mounting bracket and wall bracket with necessary hardware for ease of installation
- Integral overflow

COMPLIANCE AND CERTIFICATION:

Meets the American Disabilities Guidelines and ANSI A117.1 requirements when installed according to these requirements.

- Complies with CSA B45.5 / IAPMO Z124 & IAPMO IGC 156
- ADA Compliant
- UPC Lead Free Compliant
- Complies with
ASME A112.18.1/CSA B125.1
ASME A112.18.2/CSA B125.2 (applicable to Waste Fitting)
ASME A112.6.1M (applicable to Carrier)
NSF/ANSI 61-9 (applicable to Faucet)



This product should be used with a WaterSense labeled counterpart with a compatible flow volume to ensure that the entire system meets the requirements for water efficiency and performance.

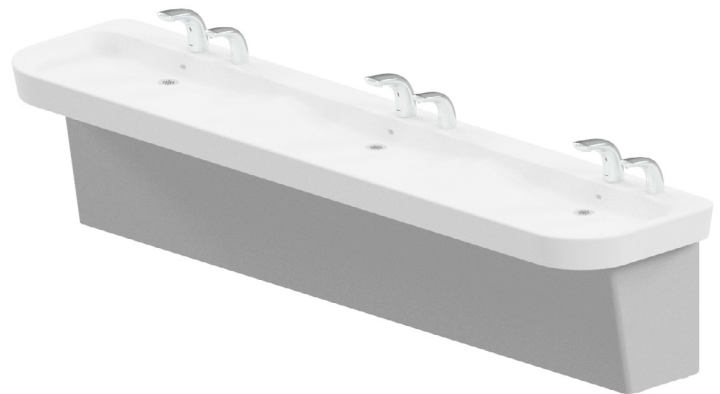

PRODUCT DESCRIPTION

Designed for modern commercial restrooms, the Sundara system delivers a superior user experience in both form and function. Crafted by world-class industrial designers Sundara combines seamless basin designs with curated faucets and soap dispensers, delivering a complete, easy to install hand washing solution.

ARCHITECTURAL & ENGINEERING APPROVAL

The information contained in this document is subject to change without notice. Please contact Zurn for most up to date information.

FAUCETS

SENSOR FAUCET



ZG6950



ZG6951



ZG6953



ZG6955



ZG6956



ZG6913



ZG6915



ZG6920

MANUAL FAUCET



Z7440-XL-FC



Z81000-XL-3M



Z81101-XL-3M



Z81104-XL-3M



Z812B4-XL-3F



Z86100-XL-3M



Z86500-XL-3M

SINK OPTIONS

Single Hole, No Faucet

4" Center Hole, No Faucet

SENSOR FAUCET POWER SUPPLY OPTIONS (COME STANDARD HYDRO POWER, BATTERY BACKUP)

-ACA Plug-in Power Converter with Battery Backup

-CWB Connecting Wire for Hardwire with Battery Backup Installation (7 ft)

SENSOR FAUCET MIXING OPTION

-No Mixing

-MV Temperature Mixing Valve for Single Faucet

-TMV-1 Thermostatic Mixing Valve for Single Faucet

SENSOR SOAP DISPENSERS (OPTIONAL)

SD Liquid Soap Dispenser

FSD Foaming Soap Dispenser

BATTERY / BATTERY PLUG-IN

• Comes with A/C Adapter

• 4 "D" size alkaline included



Z6950-SD

Z6950-FSD



Z6951-SD



Z6953-SD

Z6953-FSD



Z6956-SD

Z6956-FSD

POSITION (FOR SOAP DISPENSER ONLY)

Left

Right

No Soap Hole

Left, no soap

Right, no soap

RECOMMENDED ACCESSORIES

Z1240-EZR Sundara Lavatory carrier

P6000-HW6 Hardwired Power Converter (Powers up to 8 Faucets)

SENSOR FAUCET FLOW RATE OPTIONS

	FLOWRATE GPM [LPM]	VANDAL RESISTANT	WATERSENSE COMPLIANT	CEC, NYC 604.4 COMPLIANT	OUTLET TYPE
Standard	0.5 [1.9]	☑		☑	Spray
-E	1.5 [5.7]	☑	☑		Aerator
-J	1.5 [5.7]	☑	☑		Laminar
-K	1.0 [3.8]	☑	☑		Laminar
-L	1.0 [3.8]	☑	☑		Aerator
-M	0.35 [1.3]	☑		☑	Spray
-N	0.5 [1.9]	☑		☑	Laminar

BASIN COLORS (MUST SELECT ONE)

White (01)

Snow (02)

Sea Shell (03)

High Cliffe (04)

Sand Storm (05)

Alluvium (06)

Frost (07)



(01)



(02)



(03)

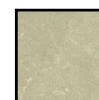

(04)



(05)

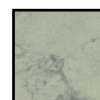

(06)



(07)

Rough-in/Overview dimensions

SENSOR FAUCET & SHARED SOAP LOCATION FOR EITHER RIGHT OR LEFT SIDE

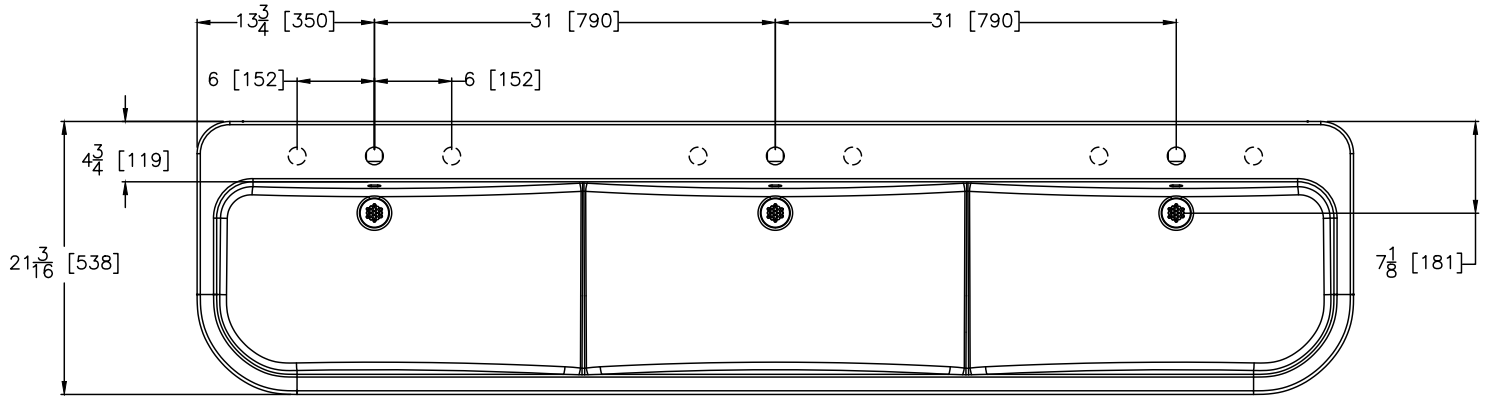

TOP VIEW

MANUAL FAUCET & SHARED SOAP LOCATION FOR 4" CENTER HOLE EITHER RIGHT OR LEFT SIDE

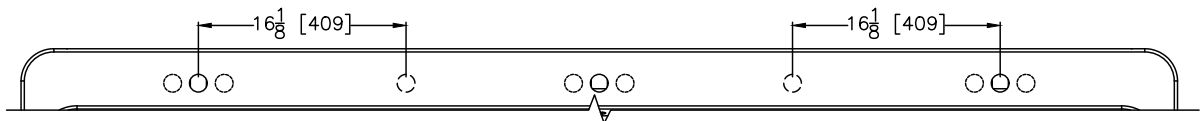

TOP VIEW

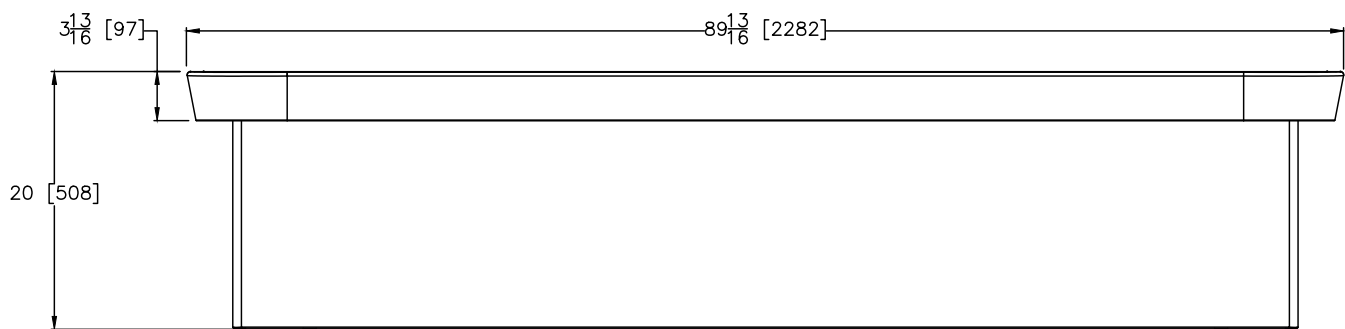

FRONT VIEW

Rough-in/Overview dimensions

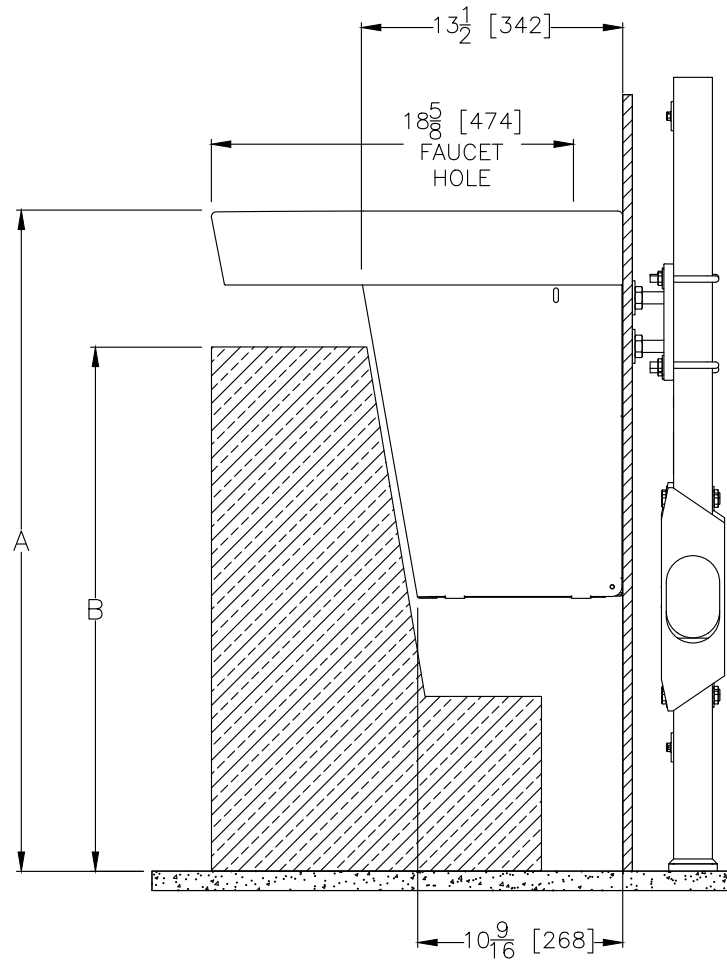

SIDE VIEW

*Shown with optional Sundara Z1240-EZR-WL

	ADA/TAS Regular Height	TAS Juvenile Height (Children 11-14 years)	ADA Juvenile Height (Children 6-12 years)	CSA Regular Height	OBC Regular Height
A	34"(863mm)	32"(812mm)	31"(787mm)	32 1/4 (820mm)	33"(838mm)
B	27"(686mm)	28"(712mm)	24"(610mm)	26 13/16"(680mm)	27"(686mm)

Rough-in/Overview dimensions

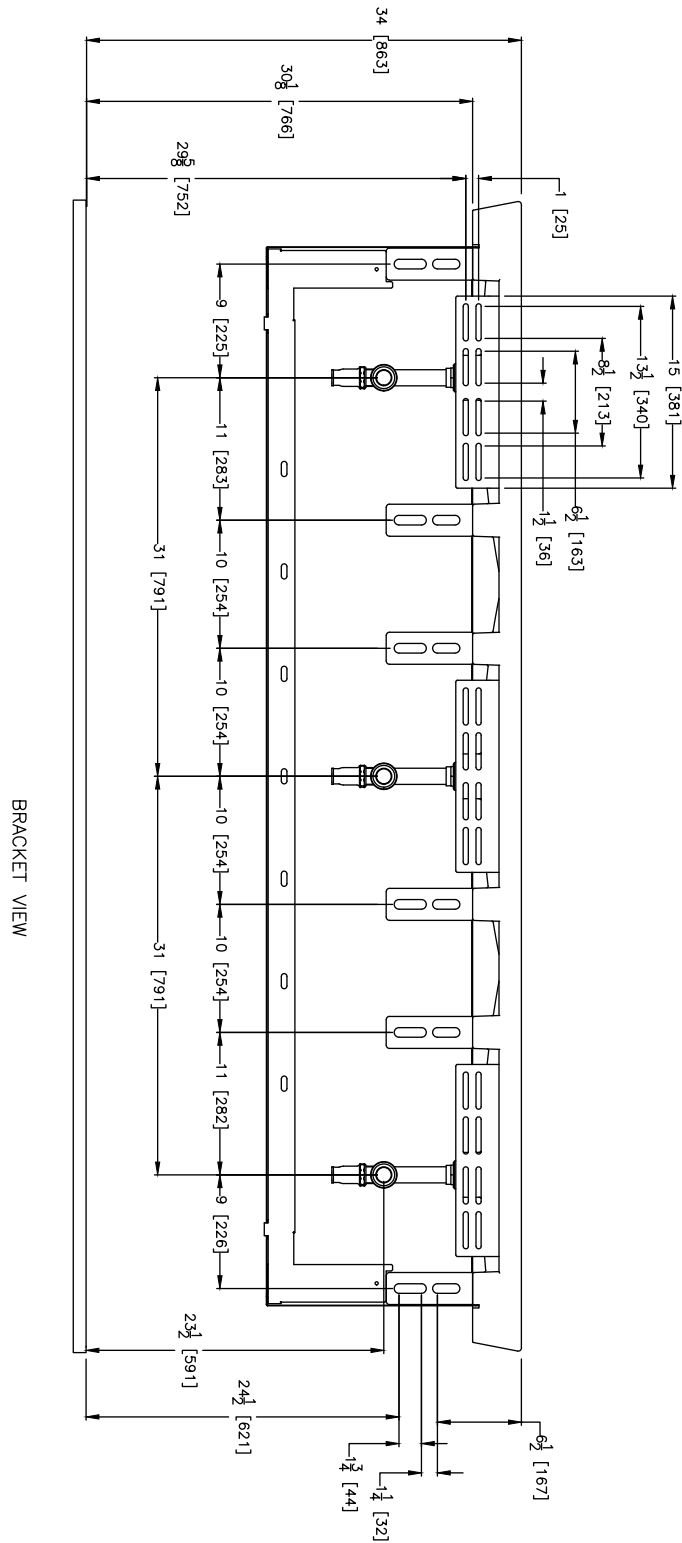

NOTE: Installing the P-trap outlet lower than 19.5" from the finished floor will prevent the vandal shroud from being installed

Rev. A | Date: 05/29/25 | C.N. No. 146620 | Prod./Dwg. No. SS Z5006.03

Patent zurn.com/patents

US 1.855.ONE.ZURN CANADA 1.877.892.5216

ZURN.COM