

ETF-500

► **Description**

Back Mounted, Sensor Activated Electronic Gooseneck Hand Washing Faucet for tempered or hot/cold water operation.

► **Flow Rate**

- 2.2 gpm/8.3 Lpm Laminar Flow Spray Head
- For 2.2 gpm/8.3 Lpm Shower Spray Head, specify "H" variation (See Accessories for other Spray Head options)

► **Specifications**

ADA Compliant, Sensor Activated, 24 VAC, Chrome Plated Brass, Gooseneck Hand Washing Faucet with the following features:

- Splash-proof Circuit Control Module
- Sensor Range Adjustment Screw
- Troubleshooting LED Indicator Lights
- User friendly Variable Time Out Settings
- Filtered Solenoid Valve with serviceable Strainer Filter
- Bak-Chek® Tee for Hot/Cold Supply
- 120 VAC/24 VAC Transformer (specify Plug-in or Box Mount)
- Spray Head with Pressure Compensating Flow Control
- Metal Jacketed Wire Protection for Sensor and Solenoid Leads
- Modular Quick-Release Sensor and Solenoid Connections

► **Variations**

(Add suffix to Model Number for inclusion with Faucet)

- **Spout and Spray Head Variations**
 - H** Shower Spray Head (2.2 gpm/8.3 Lpm)
 - S** Surgical Bend Spout
- **Transformer Type** (must be specified)
 - P** Plug-in Transformer (furnished with ETF-233)
 - B** Box Mount (furnished with EL-248-40)
 - LT** Less Transformer (specify Transformer separately - See Accessories)
- **Temperature Mixing Valves** (optional)
 - BDM** Below Deck Mechanical Mixing Valve
 - BDT** Below Deck Thermostatic Mixing Valve

Bak-Chek® Tee not required or provided when a Temperature Mixing Valve is included with the faucet.

Consult Factory for Finish Variations

► **Accessories** (Specify separately)

- **Transformers**
 - ETF-233** 120 VAC/24 VAC, 50/60 Hz (35 VA) - Plug-in (will operate up to 2 faucets)
 - EL-248-40** 120 VAC/24 VAC, 50/60 HZ (40 VA) - Box Mount (will operate up to 2 faucets)
 - EL-154** 120 VAC/24 VAC, 50/60 Hz (50 VA) - Box Mount (will operate up to 3 faucets)
 - EL-208** 120 VAC/24 VAC, 50/60 Hz (100 VA) - Foot Mount (will operate up to 6 faucets)
 - EL-342** 240 VAC/24 VAC, 50/60 Hz (50 VA) - Box Mount (will operate up to 3 faucets)
- **Spray Head**
 - ETF-687** 1.5 gpm/5.7 Lpm Laminar Flow Spray Head
 - ETF-801** 0.5 gpm/1.9 Lpm Spray Head
- **Grid Strainer**
 - ETF-460-A** Chrome Plated Brass Grid Strainer w/1¼" Outlet Tube

See OPTIMA Accessories Section of the Sloan Catalog for a complete listing of OPTIMA Faucet Accessories and Variations.



► **ADA Compliant**

► **Automatic**

The Sloan OPTIMA® ETF-500 Electronic Gooseneck Hand Washing Faucet operates by means of an infrared sensor. Once the user's hands enter the sensor's effective range, the Solenoid activates the water flow. Tempered water flows from the Faucet until hands are moved away. The Faucet then automatically shuts off and resets for the next use.

► **Hygienic**

The ultimate in sanitary protection — there are no handles to turn or buttons to push. Helps to control the spread of infectious diseases. Ideal for health care applications.

► **Economical**

Automatic operation provides water usage savings over other faucet devices. Reduces maintenance and operation costs.

► **Warranty**

3 year (limited)

► **Compliant to:**

ASME A112.18.1 and CSA B125.1



LISTED 376U



This space for Architect/Engineer approval

Job Name _____ Date _____

Model Specified _____ Quantity _____

Variations Specified _____

Customer/Wholesaler _____

Contractor _____

Architect _____

The information contained in this document is subject to change without notice.

ETF-500

Description

Back Mounted, Sensor Activated Electronic Gooseneck Hand Washing Faucet for tempered or hot/cold water operation.

Flow Rate

□ 2.2 gpm/8.3 Lpm Laminar Flow Spray Head
 For 2.2 gpm/8.3 Lpm Shower Spray Head, specify "H" variation
 (See Accessories for other Spray Head options)



ETF-500-S-H
Surgical Bend

ELECTRICAL SPECIFICATIONS

Control Circuit

24 VAC Input/Output, 50/60 Hz, Adjustable Range & Time Out Settings, Modular Plugs & Troubleshooting LED Indicators

OPTIMA® Sensor Range

Factory Set: 6" - 8" (152 mm - 203 mm)
 Adjustable: 1" - 14" (25 mm - 356 mm)

Solenoid Valve

24 VAC 50/60 Hz with Integral Strainer Filter & Compression Connection Inlet/Outlet.

Time Out Adjustment Settings

3, 6, 12, 30 & 45 seconds; 1, 3 & 20 minutes. The Faucet Time Out Setting determines the maximum time the faucet will run upon continuous activation. This timing can be changed to meet individual application requirements. Unless otherwise specified the ETF-500 is factory set at the 30 second time out.

Transformer

All Sloan Transformers are 50/60 Hz. Multiple faucets can be powered by a single transformer, provided that the transformer has been properly sized. Allow a minimum of 15 VA of current rating for each faucet being used.

Plug-in	ETF-233	120 VAC/24 VAC - 35 VA (supplied with "P" variation)
Box Mount	EL-248-40	120 VAC/24 VAC - 40 VA (supplied with "B" variation)
Box Mount	EL-154	120 VAC/24 VAC - 50 VA
Foot Mount	EL-208	120 VAC/24 VAC - 100 VA
Box Mount	EL-342	240 VAC/24 VAC - 50 VA

Max. Distance Control Module may be Installed from Spout

With Standard Cable: 12" (305 mm)

Extension Cables (Optional)

From Sensor to Control Module:		From Solenoid Valve to Control Module:	
ETF-1005-26	26" (660 mm)	ETF-1003-36	36" (914 mm)
ETF-1005-36	36" (914 mm)	ETF-1003-48	48" (1219 mm)
ETF-1005-72	72" (1829 mm)	ETF-1003-72	72" (1829 mm)
ETF-1005-108	108" (2743 mm)	ETF-1003-108	108" (2743 mm)

OPERATION

1. A continuous invisible beam of light is emitted from the OPTIMA® Sensor located at the base of the lavatory faucet.

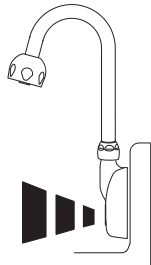

2. As the user's hands enter the beam's effective range, the beam is reflected back into the sensor receiver and activates the solenoid valve allowing tempered water to flow from the faucet. Water will flow until the hands are removed or until the faucet reaches its automatic time out limit setting.

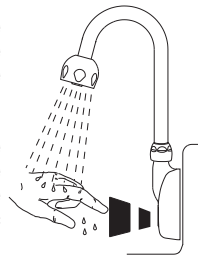

3. When hands are moved away from the OPTIMA® Sensor, the loss of reflected light initiates an electrical signal that deactivates the Solenoid Valve shutting off the water flow. The Circuit then automatically resets and is ready for the next user.

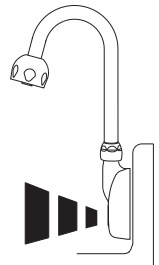

ROUGH-IN

ETF-500 Faucet with Bak-Chek® Tee for Hot and Cold Water Supply

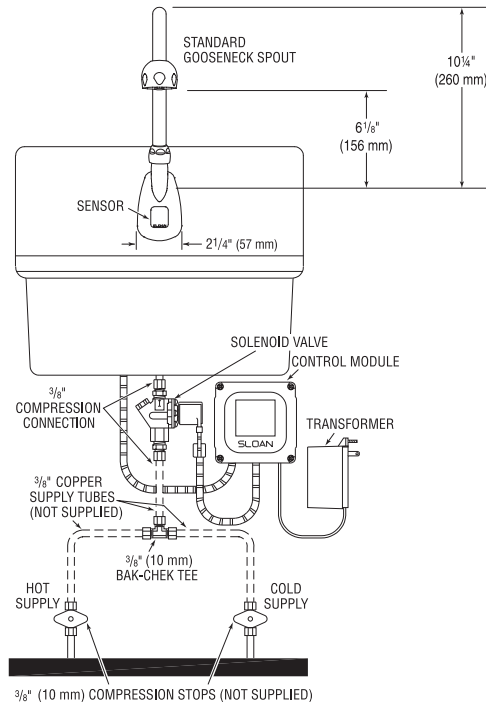

ETF-500 Faucet with BDM and BDT Variation Mixing Valves for Hot and Cold Water Supply

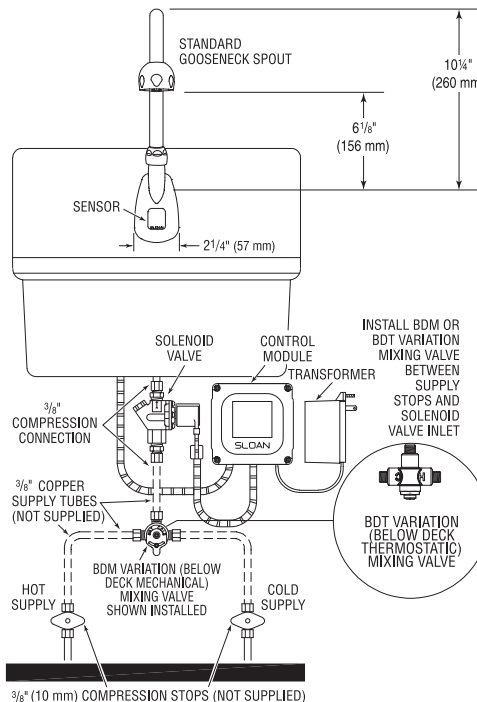

Rough-in Dimensions (side view)

ETF-500-H with Standard Spout and Shower Spray Head

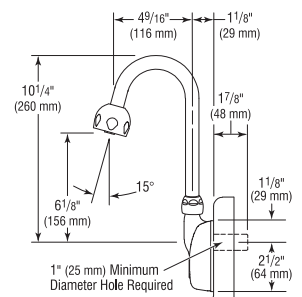

ETF-500-S-H with Surgical Bend Spout and Shower Spray Head

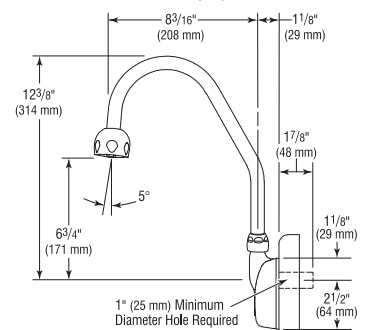

SLOAN VALVE COMPANY • 10500 SEYMOUR AVENUE • FRANKLIN PARK, IL 60131

Phone: 1-800-982-5839 or 1-847-671-4300 • Fax: 1-800-447-8329 or 1-847-671-4380 • www.sloanvalve.com