

CODE NUMBER

3013860

DESCRIPTION

3.5 gpf, Rough Brass Finish, Single Flush, 8.75 L Dimension, Royal® Exposed Manual Specialty Water Closet Foot Pedal Flushometer.

DETAILS

- Flush Volume: 3.5 gpf (13.2 Lpf)
- Finish: Rough Brass (RB)
- Valve: Diaphragm
- Valve Body Material: Semi-red Brass
- Fixture Type: Water Closet
- Fixture Connection: Top spud
- Rough-In Dimension: 14" (356mm)
- Spud Coupling: 1 ½" (38mm)
- Supply Pipe: 1" (25mm)
- L Dimension: 8 ¾" (222mm) (8-3/4-LDIM)

FEATURES

- Varying flush volumes start as low as 1.6 gpf/6.0 Lpf
- Water conservation is aided by non-hold-open foot pedal (not ADA compliant)
- Flush accuracy is controlled by CID™ technology, also enhancing water efficiency
- Durability is facilitated with high copper, low zinc brass castings for dezincification resistance
- PERMEX synthetic rubber diaphragm with Dual Filtered Fixed Bypass
- Valve body, Cover, Tailpiece and Control Stop shall be in compliance with ASTM Alloy Classification for Semi-Red Brass
- Valve shall be in compliance to the applicable sections of ASSE 1037.



COMPLIANCES & CERTIFICATIONS



(UPC Certified, BAA Compliant)

RECOMMENDED SPECIFICATION

Valve Body, Cover, Tailpiece and Control Stop shall be in conformance with ASTM Alloy Classification for Semi- Red Brass. Valve shall be in compliance with the applicable sections of ASSE 1037 and ANSI/ASME 112.19.2.

VALVE OPERATING PRESSURE (FLOWING)

15–80 PSI (103–552 kPa). Specific fixtures may require greater minimum flowing pressure - consult manufacturer requirements.

DOWNLOADS

- [Royal/Regal/Crown Naval Foot Pedal Flushometer Installation Instructions](#)
- [Control Stop Repair and Maintenance Guide](#)
- [Flush Connections Flanges Repair and Maintenance Guide](#)
- [Tail Piece Repair and Maintenance Guide](#)
- [Royal Flushometers Repair and Maintenance Guide](#)
- [Additional Downloads](#)

NOTES

All information contained within this document subject to change without notice.

Looking for other variations of the ROYAL 313 product? [View the general spec sheet with all options.](#)

[Find a compatible urinal](#) for this flushometer.

[Find a compatible water closet](#) for this flushometer.

Sloan 10500 Seymour Ave, Franklin Park, IL 60131

Phone: 800.982.5839 • Fax: 800.447.8329 • sloan.com

ROUGH-IN

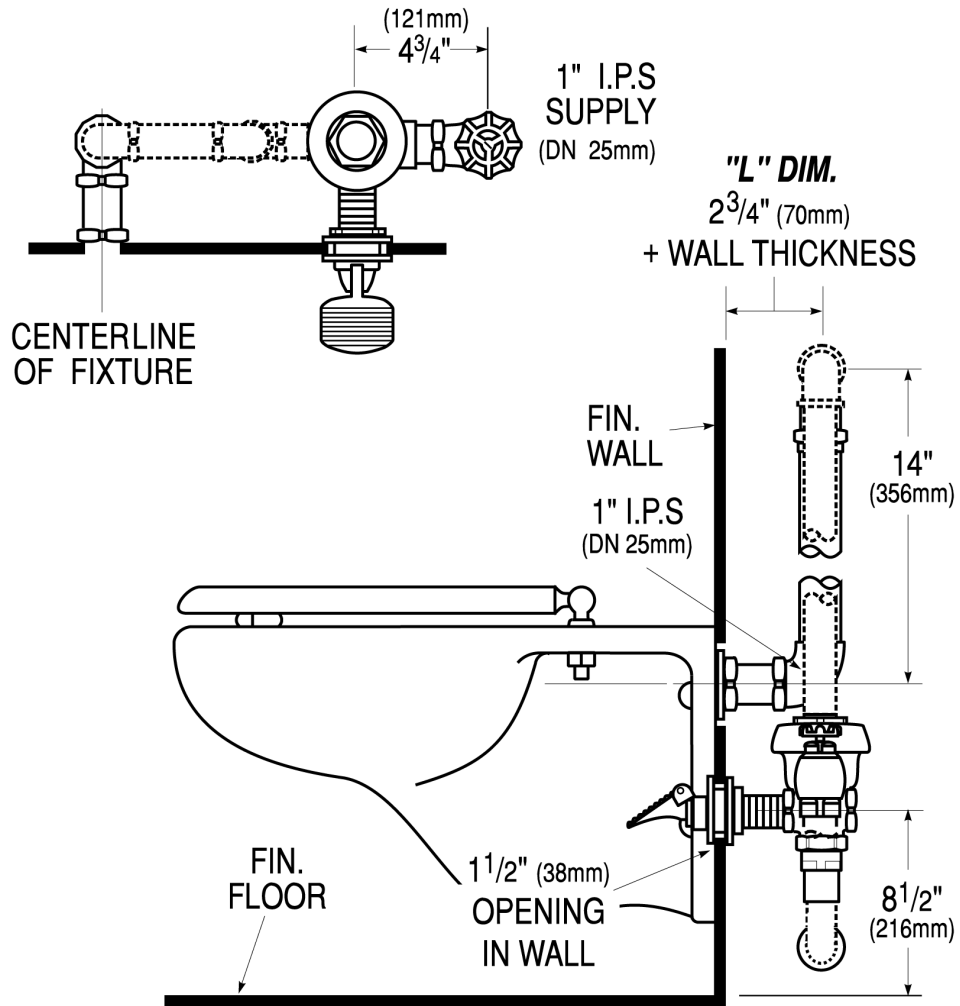

Sloan 10500 Seymour Ave, Franklin Park, IL 60131
Phone: 800.982.5839 • Fax: 800.447.8329 • sloan.com