

Shower Systems

SH-TP5-26-020

Product Type

Thermostatic/pressure balancing shower fitting with Auto-Drain® and hand spray

Features & Specifications

- Includes shower head arm and wall flange
- 1920-VONF thermostatic/pressure balancing tub and shower valve
- 2.5 GPM hand spray with pause control; two 34" stainless steel hoses with Auto-Drain®
- Includes wall-mounted Auto-Drain®
- Integral service stops with checks to prevent cross flow
- Thermostatic/pressure balancing cartridge
- Complies with the requirements of the Buy American Act of 1933.



Performance Specification

- Rated Operating Pressure: 40-125 PSI
- Rated Operating Temperature: 40-120°F

Warranty

- 5-Year Limited Faucet Warranty
- 5-Year Limited Cartridge Warranty
- 1-Year Limited Finish Warranty

Codes & Standards

-  ADA ANSI/ICC A117.1
- ASSE 1014
- Complies with ASSE 1016/ASME A112.1016/CSA B125.16
- NOTE: Per the California Energy Commission (CEC), this fitting is not intended to be sold in California. See the CEC website for details.
-  ASME A112.18.1/CSA B125.1

Job Name _____

Item Number _____

Section/Tag _____

Model Specified _____

Architect _____

Engineer _____

Contractor _____

Submitted as Shown

Submitted with Variations

Date _____



2100 South Clearwater Drive
Des Plaines, IL
P: 847/803-5000
F: 847/803-5454
Technical: 800/TEC-TRUE
www.chicagofaucets.com

Architect/Engineer Specification

Chicago Faucets No. SH-TP5-26-020, Shower System with Auto-Drain®, thermostatic/pressure balancing valve, wall-mounted. Chrome plated. Includes shower head with ball joint, 2.5 GPM max. flow rate @ 80 PSI, thermostatic/pressure balancing cartridge; wall elbow with in-line air vent, 2.5 GPM hand spray with pause control; two 34" stainless steel hoses with automatic hose drain, wall-mounted hand spray holder. Auto-Drain® diverter valve switches between shower head and hand spray. 1/2" nominal copper and 1/2" NPT hot and cold supply inlets and outlets. Shower valve cycles from cold to hot. Wall plate includes embossed and color-coded temperature index. Integral service stops with checks to prevent cross-flow. This product meets ADA ANSI/ICC A117.1 requirements and is tested and certified to industry standards: ASME A112.18.1/CSA B125.1, and ASSE 1016.

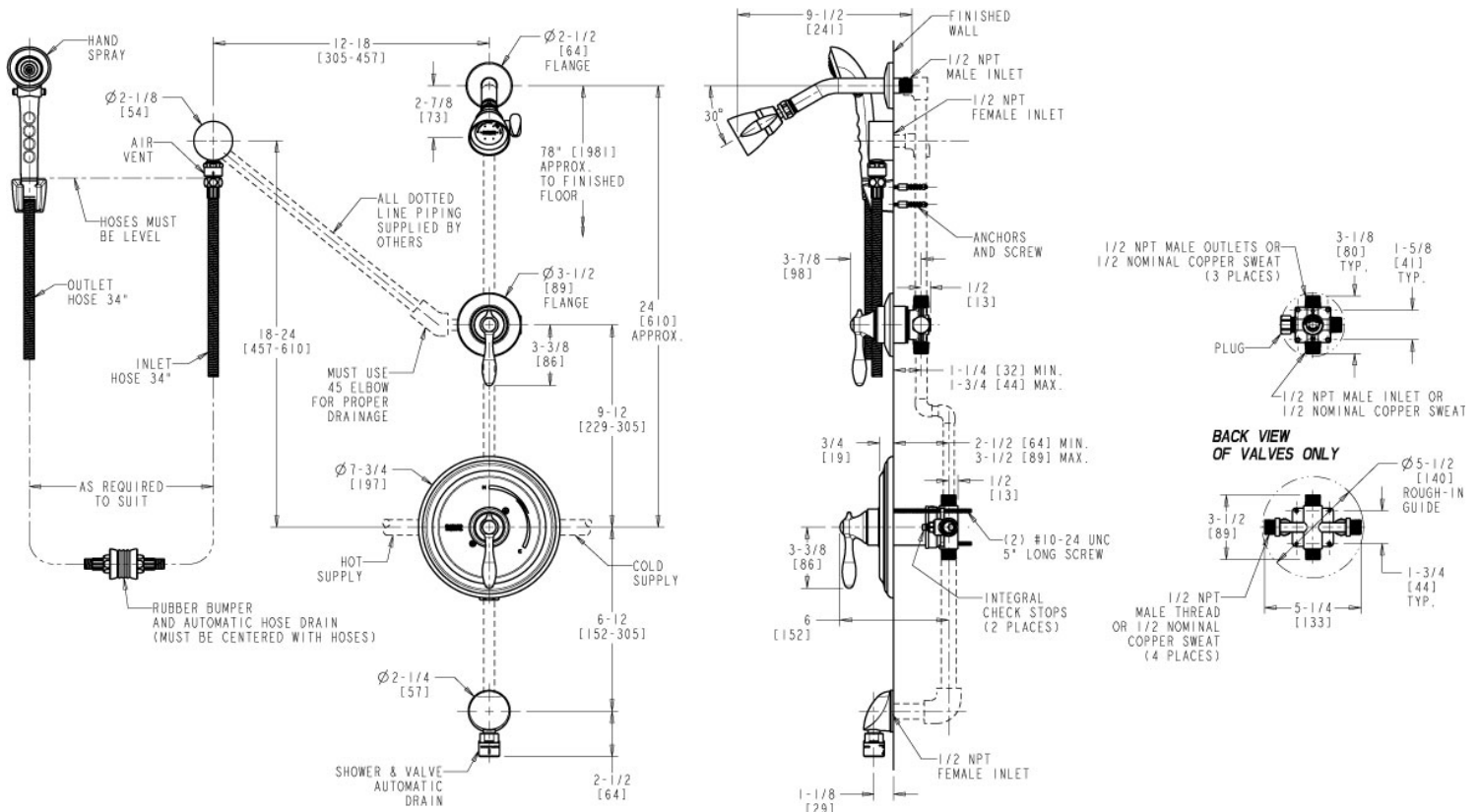

Operation and Maintenance

Installation should be in accordance with local plumbing codes. Flush all pipes thoroughly before installation. After installation, remove spout outlet or flow control and flush faucet thoroughly to clear any debris. Care should be taken when cleaning the product. Do not use abrasive cleaners, chemicals or solvents as they can result in surface damage. Use mild soap and warm water for cleaning and protecting the life of Chicago Faucet products. For specific operation and maintenance refer to the installation instructions and repair parts documents that are located at www.chicagofaucets.com.

Chicago Faucets, member of the Geberit Group, is the leading brand of commercial faucets and fittings in the United States, offering a complete range of products for schools, laboratories, hospitals, office buildings, food service, airports and sport facilities. Call 1.800.TECTRUE or 1.847.803.5000 Option 1 for installation or other technical assistance.

