

Touchless Faucets ELR-E12E-13ABCPT

Product Type

Touchless ligature resistant faucet

Features & Specifications

- Includes built-in ASSE 1070 thermostatic mixing valve concealed within control box
- 40 second run time with hand presence. Safety auto-timeout feature will shut the water off after 40 seconds. Reactivate faucet by removing hands from the sensor for at least 10 seconds.
- Built-in Bluetooth® technology allows for easy adjustments and mode changes using a smartphone or tablet with the Chicago Faucets CF Connect App.
- Internal Antenna Specifications: Peak Gain of the antenna: +1.51 dBi, Frequency range: 2400-2500 MHz, FCC ID: 2APTX-CFC03
- 4" fixed centers
- Vandal Proof Pressure compensating laminar flow outlet, 1.0 GPM
- ECAST® design provides durable cast brass construction with total lead content equal to or less than 0.25% by weighted average
- Complies with the requirements of the Buy American Act of 1933.







Performance Specification

- Rated Operating Pressure: Rated Operating Pressure: Operating static pressure: 20-125 PSI. Minimum static pressure for mixing 30 PSI. Cold water inlet range: 39-80°F (4-27°C). Hot water inlet range: 100-180°F (38-82°C). Mixed water temperature range: 80-120°F (27-49°C). Minimum flow rate for proper functioning of thermostatic protection: 0.35 GPM (1.3 LPM). Maximum pressure differential between hot and cold water supplies: 20%. Minimum inlet water supply temperature differential: 20°F (11°C). This fitting is NOT factory preset and can be adjusted to deliver water at temperatures exceeding 110°F (43°C).

Warranty

- 3-Year Limited Electronics and Solenoid Warranty
- Lifetime Limited Faucet Warranty
- 1-Year Limited Finish Warranty
- 5-Year Limited Mechanical Warranty

Codes & Standards

-  ASME A112.18.1/CSA B125.1
-  ADA ANSI/ICC A117.1
-  Certified to ASSE 1070 / ASME A112.1070 / CSA B125.70
- This product, when installed in accordance with the Installation Instructions, is designed to decrease the probability that it may be used as an apparatus for ligature. Chicago Faucets does not represent or warrant that this product is able to prevent death or injury, or resist all ligature attachment, and this product is not a substitute for the proper evaluation, treatment, and supervision of persons at risk of suicide. Chicago Faucets makes no express or implied warranties regarding the ability of the product to prevent death or injury or resist all ligature attachment.
-  NSF/ANSI/CAN 61: Q ≤ 1
-  NSF/ANSI/CAN 372 Low Lead Content
- Approved by the New York State Office of Mental Health
-  Certified to WaterSense by ICC-ES

Job Name _____

Item Number _____

Section/Tag _____

Model Specified _____

Architect _____

Engineer _____

Contractor _____

Submitted as Shown Submitted with Variations

Date _____



ECAST

ECAST products are intended for installation where state laws and local codes mandate lead content levels or in any location where lead content is a concern.



2100 South Clearwater Drive
Des Plaines, IL
P: 847/803-5000
F: 847/803-5454
Technical: 800/TEC-TRUE
www.chicagofaucets.com

Architect/Engineer Specification

Chicago Faucets No. ELR-E12E-13ABCPT, Electronic ligature resistant faucet with dual-beam infrared sensor. Integral spout, chrome plated. 4" deck mount. 1.0 GPM (3.8 L/min) vandal-proof, pressure compensating, Econo-Flo, laminar flow. Dual supply for hot and cold water service. Powered from 4 "AA" Alkaline Batteries (Included) - Up to 5 Year Battery Life. Flexible supply hoses included. Pre-assembled with Concealed Internal Thermostatic Control Mixer. Multiple field-adjustable modes and ranges. Built-in Bluetooth® technology allows for easy adjustments and mode changes using a smartphone or tablet with the Chicago Faucets CF Connect App. ECAST® construction with less than 0.25% lead content by weighted average. CALGreen compliant. This product meets ADA ANSI/ICC A117.1 requirements and is tested and certified to industry standards: ASME A112.18.1/CSA B125.1, Certified to NSF/ANSI 61, Section 9, ASSE 1070, California Health and Safety Code 116875 (AB1953-2006), Vermont Bill S.152, NSF/ANSI 372 Low Lead Content, and California Green Building Standards Code (CALGreen). *DISCLAIMER: This product, when installed in accordance with the Installation Instructions, is designed to decrease the probability that it may be utilized as an apparatus for ligature. Chicago Faucets does not represent or warrant that this product is able to prevent death or injury, or resist all ligature attachment, and this product is not a substitute for the proper evaluation, treatment, and supervision of persons at risk of suicide. Chicago Faucets makes no express or implied warranties regarding the ability of the product to prevent death or injury or resist all ligature attachment.

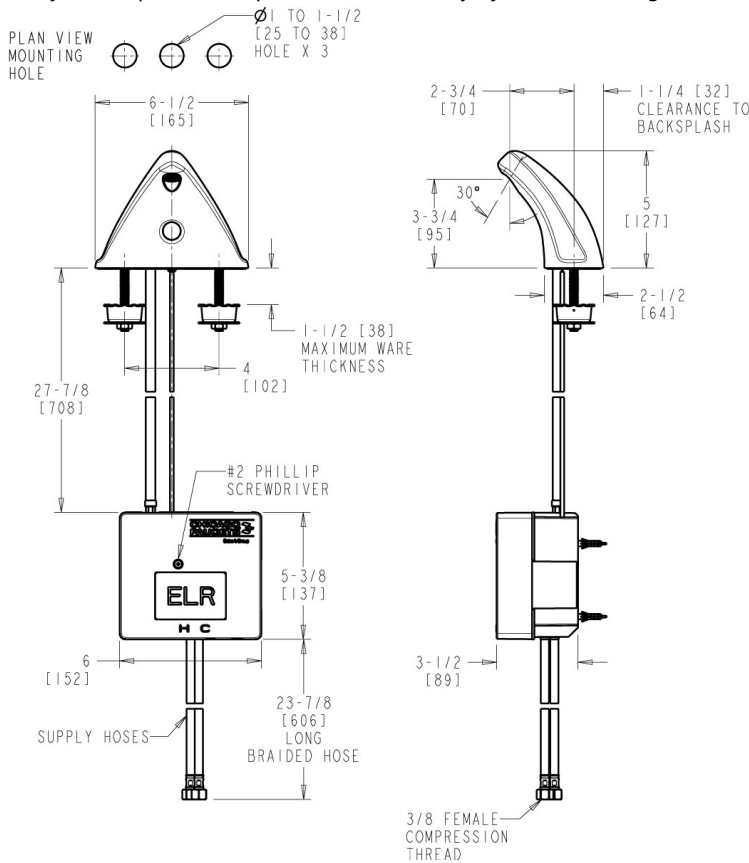

Operation and Maintenance

Installation should be in accordance with local plumbing codes. Flush all pipes thoroughly before installation. After installation, remove spout outlet or flow control and flush faucet thoroughly to clear any debris. Care should be taken when cleaning the product. Do not use abrasive cleaners, chemicals or solvents as they can result in surface damage. Use mild soap and warm water for cleaning and protecting the life of Chicago Faucet products. For specific operation and maintenance refer to the installation instructions and repair parts documents that are located at www.chicagofaucets.com.

Chicago Faucets, member of the Geberit Group, is the leading brand of commercial faucets and fittings in the United States, offering a complete range of products for schools, laboratories, hospitals, office buildings, food service, airports and sport facilities. Call 1.800.TECTRUE or 1.847.803.5000 Option 1 for installation or other technical assistance.

