

Safety Fittings

8453-F11J-13ABCPT

Product Type

Touchless emergency eyewash with faucet

Features & Specifications

- Eyewash outlet: 3.3 GPM at 50 PSI
- Built-in Bluetooth® technology allows for easy adjustments and mode changes using a smartphone or tablet with the Chicago Faucets CF Connect App.
- Internal Antenna Specifications: Peak Gain of the antenna: +1.51 dBi, Frequency range: 2400-2500 MHz, FCC ID: 2APTX-CFC03
- Vandal Proof Pressure compensating Softflo aerator, 2.2 GPM
- ECAST® design provides durable cast brass construction with total lead content equal to or less than 0.25% by weighted average
- Complies with the requirements of the Buy American Act of 1933.





Performance Specification

- Rated Operating Pressure: 20-125 PSI (faucet); 22-116 PSI - recommended 50 PSI (eyewash)
- Rated Operating Temperature: 40-140°F (faucet); 50-90°F (eyewash)

Warranty

- 3-Year Limited Electronics and Solenoid Warranty
- Lifetime Limited Faucet Warranty
- 1-Year Limited Finish Warranty
- 5-Year Limited Mechanical Warranty

Codes & Standards

-  ADA ANSI/ICC A117.1
-  ANSI/ISEA Z358.1 Standard for Emergency Eyewash and Shower Equipment
-  ASME A112.18.1/CSA B125.1
-  Certified to ASSE 1070 / ASME A112.1070 / CSA B125.70
-  NSF/ANSI/CAN 372 Low Lead Content

Job Name _____

Item Number _____

Section/Tag _____

Model Specified _____

Architect _____

Engineer _____

Contractor _____

Submitted as Shown Submitted with Variations

Date _____

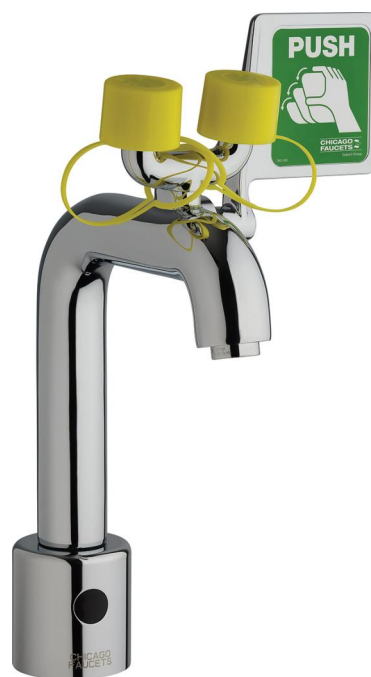

ECAST

ECAST products are intended for installation where state laws and local codes mandate lead content levels or in any location where lead content is a concern.



2100 South Clearwater Drive
Des Plaines, IL
P: 847/803-5000
F: 847/803-5454
Technical: 800/TEC-TRUE
www.chicagofaucets.com

Architect/Engineer Specification

Chicago Faucets 8453-F11J-13ABCPT, Eyewash Faucet with push paddle handle, deck-mounted. 2.2 GPM (8.3 L/min) vandal-proof, pressure compensating, SoftFlo outlet. Dual supply. Powered by 4 "AA" alkaline batteries (included) - up to 5-year battery life. Includes stainless steel braided hose(s). Includes concealed thermostatic mixing valve. On-demand IR detection for hands-free actuation and maximum water savings. Built-in Bluetooth® technology allows for easy adjustments and mode changes using a smartphone or tablet with the Chicago Faucets CF Connect App. Certified to the ANSI/ISEA Z358.1 Standard for Emergency Eyewash and Shower Equipment, ASME A112.18.1/CSA B125.1 Plumbing Supply Fittings, and NSF/ANSI 372 Drinking Water Systems Components-Lead Content. ASSE 1070 Certified. Certified to NSF/ANSI 61, Section 9, California Health and Safety Code 116875 (AB1953-2006), Vermont Bill S.152, NSF/ANSI 372 Low Lead Content.

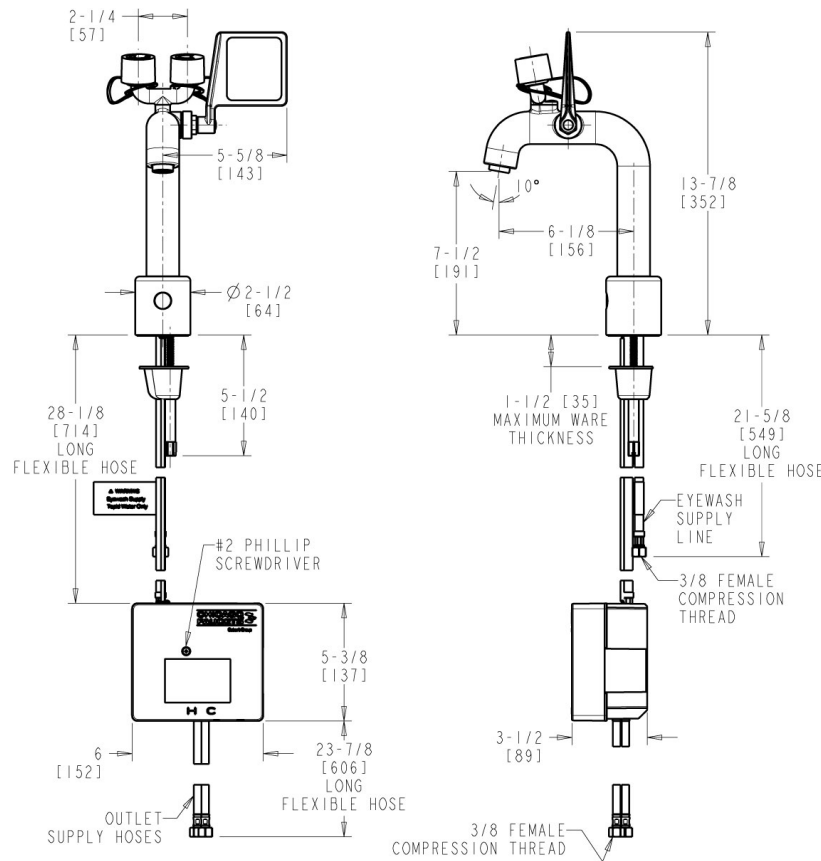

Operation and Maintenance

Installation should be in accordance with local plumbing codes. Flush all pipes thoroughly before installation. After installation, remove spout outlet or flow control and flush faucet thoroughly to clear any debris. Care should be taken when cleaning the product. Do not use abrasive cleaners, chemicals or solvents as they can result in surface damage. Use mild soap and warm water for cleaning and protecting the life of Chicago Faucet products. For specific operation and maintenance refer to the installation instructions and repair parts documents that are located at www.chicagofaucets.com.

Chicago Faucets, member of the Geberit Group, is the leading brand of commercial faucets and fittings in the United States, offering a complete range of products for schools, laboratories, hospitals, office buildings, food service, airports and sport facilities. Call 1.800.TECTRUE or 1.847.803.5000 Option 1 for installation or other technical assistance.

