

Safety Fittings 8451-TABCP

Product Type

Single-handle emergency eyewash with faucet, ASSE 1071 valve, gauge, and locking ball valves

Features & Specifications

- Eyewash outlet: 3.3 GPM at 50 PSI
- Vandal Proof Pressure compensating Softflo aerator, 2.2 GPM
- 2-3/4" Lever handle
- Ceramic operating cartridge with volume control and hot water limit stop
- ECAST® design provides durable cast brass construction with total lead content equal to or less than 0.25% by weighted average
- Complies with the requirements of the Buy American Act of 1933.
- CFNow! Item Ships in 3 Days





Performance Specification

- Rated Operating Pressure: 20-125 PSI (faucet); 22-116 PSI - recommended 50 PSI (eyewash)
- Rated Operating Temperature: 40-140°F (faucet); 50-90°F (eyewash)

Warranty

- 1-Year Limited Material Warranty
- 1-Year Limited Finish Warranty

Codes & Standards

-  ADA ANSI/ICC A117.1
-  ANSI/ISEA Z358.1 Standard for Emergency Eyewash and Shower Equipment
-  ASSE 1071 Temperature Actuated Mixing Valves for Plumbed Emergency Equipment
-  ASME A112.18.1/CSA B125.1
-  NSF/ANSI/CAN 372 Low Lead Content

Job Name _____

Item Number _____

Section/Tag _____

Model Specified _____

Architect _____

Engineer _____

Contractor _____

Submitted as Shown

Submitted with Variations

Date _____



ECAST

ECAST products are intended for installation where state laws and local codes mandate lead content levels or in any location where lead content is a concern.



2100 South Clearwater Drive
Des Plaines, IL
P: 847/803-5000
F: 847/803-5454
Technical: 800/TEC-TRUE
www.chicagofaucets.com

Architect/Engineer Specification

Chicago Faucets 8451-TABCP, Eyewash Faucet with push paddle handle, deck-mounted. 3/8" Compression inlet. 3/8" Compression x 1/2 NPSM Male Adapter. Certified to the ANSI/ISEA Z358.1 Standard for Emergency Eyewash and Shower Equipment, ASME A112.18.1/CSA B125.1 Plumbing Supply Fittings, NSF/ANSI 372 Drinking Water Systems Components-Lead Content, and ASSE 1071 Temperature Actuated Mixing Valves for Plumbed Emergency Equipment.

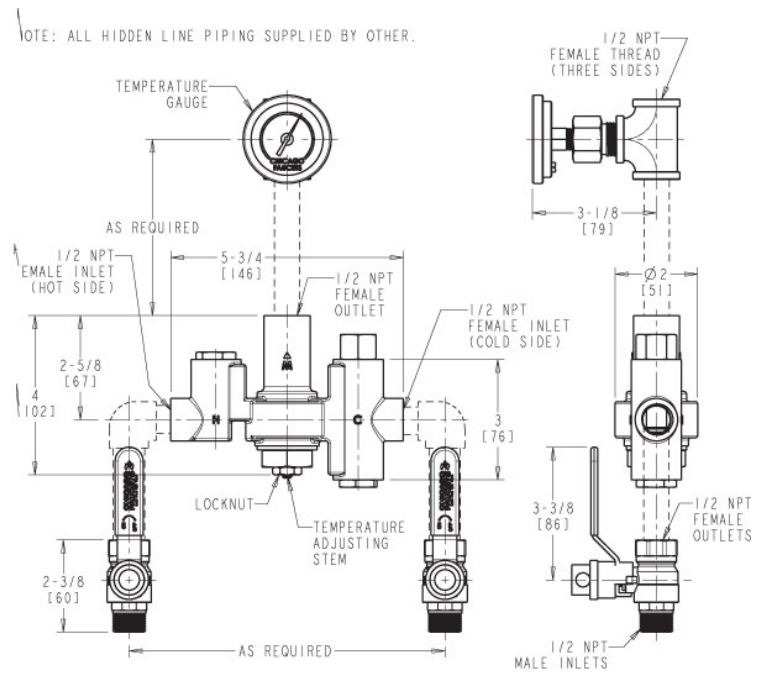
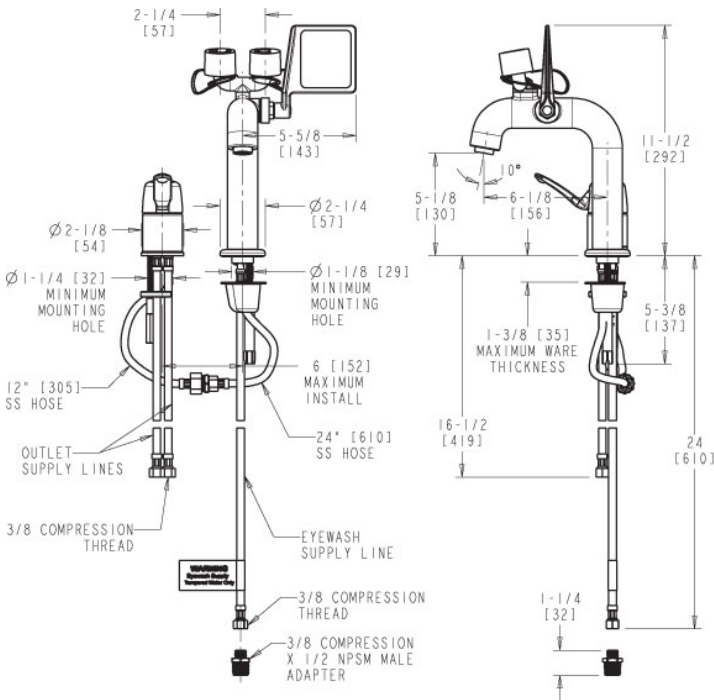

Operation and Maintenance

Installation should be in accordance with local plumbing codes. Flush all pipes thoroughly before installation. After installation, remove spout outlet or flow control and flush faucet thoroughly to clear any debris. Care should be taken when cleaning the product. Do not use abrasive cleaners, chemicals or solvents as they can result in surface damage. Use mild soap and warm water for cleaning and protecting the life of Chicago Faucet products. For specific operation and maintenance refer to the installation instructions and repair parts documents that are located at www.chicagofaucets.com.

Chicago Faucets, member of the Geberit Group, is the leading brand of commercial faucets and fittings in the United States, offering a complete range of products for schools, laboratories, hospitals, office buildings, food service, airports and sport facilities. Call 1.800.TECTRUE or 1.847.803.5000 Option 1 for installation or other technical assistance.



2100 South Clearwater Drive
Des Plaines, IL
P: 847/803-5000
F: 847/803-5454
Technical: 800/TEC-TRUE
www.chicagofaucets.com