

Shower Systems

1907-622LCP

Product Type

Thermostatic/pressure balancing tub and shower fitting with shower head and diverter tub spout options

Features & Specifications

- Cartridge for thermostatic/pressure balancing shower valve
- Complies with the requirements of the Buy American Act of 1933.



Performance Specification

- Rated Operating Pressure: 20-125 PSI
- Rated Operating Temperature: 90-110°F
- Maximum Hot Water Supply Temperature: 190°F (88°C)
- Minimum Hot Water Supply Temperature (Approach Temperature): 10°F (5.5°C) Above Set Point

Warranty

- 5-Year Limited Cartridge Warranty
- Lifetime Limited Faucet Warranty
- 1-Year Limited Finish Warranty

Codes & Standards

-  ADA ANSI/ICC A117.1
-  Certified to ASSE 1016/ASME A112.1016/CSA B125.16
-  Certified to WaterSense by ICC-ES

Job Name _____

Item Number _____

Section/Tag _____

Model Specified _____

Architect _____

Engineer _____

Contractor _____

Submitted as Shown Submitted with Variations

Date _____



2100 South Clearwater Drive
Des Plaines, IL
P: 847/803-5000
F: 847/803-5454
Technical: 800/TEC-TRUE
www.chicagofaucets.com

Architect/Engineer Specification

Chicago Faucets No. 1907-622LCP, Tub and Shower Valve, thermostatic/pressure balancing, wall-mounted, with shower head. Chrome plated trim. Shower head with ball joint, 1.5 GPM max. flow rate @ 80 PSI. Includes thermostatic/pressure balancing cartridge. 1/2" nominal, copper, hot and cold supply inlets and outlets. Shower head includes arm and wall flange. Shower valve cycles from cold to hot. Includes integral service stops. This product meets ADA ANSI/ICC A117.1 requirements and is tested and certified to industry standards: ASME A112.18.1/CSA B125.1, and ASSE 1016.

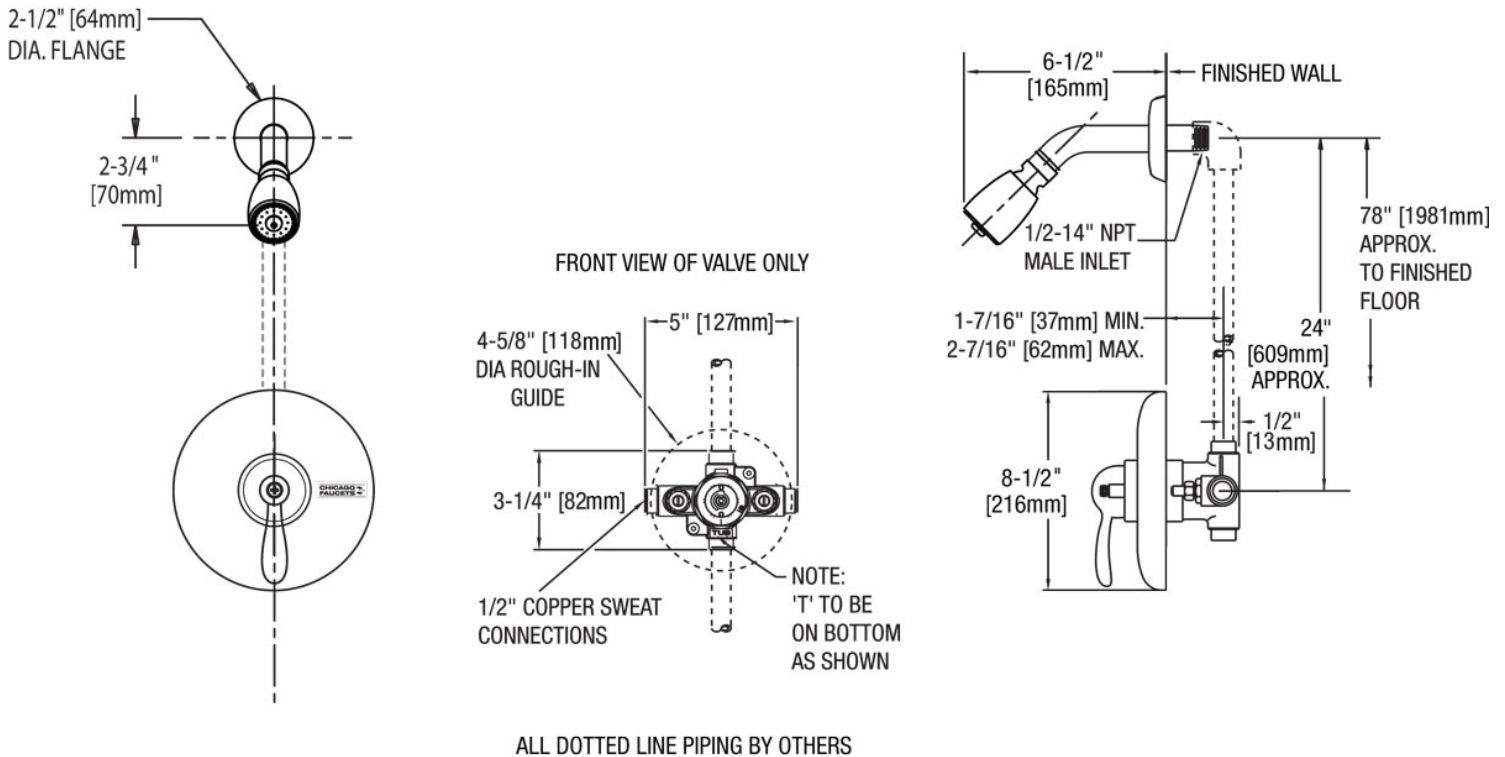

Operation and Maintenance

Installation should be in accordance with local plumbing codes. Flush all pipes thoroughly before installation. After installation, remove spout outlet or flow control and flush faucet thoroughly to clear any debris. Care should be taken when cleaning the product. Do not use abrasive cleaners, chemicals or solvents as they can result in surface damage. Use mild soap and warm water for cleaning and protecting the life of Chicago Faucet products. For specific operation and maintenance refer to the installation instructions and repair parts documents that are located at www.chicagofaucets.com.

Chicago Faucets, member of the Geberit Group, is the leading brand of commercial faucets and fittings in the United States, offering a complete range of products for schools, laboratories, hospitals, office buildings, food service, airports and sport facilities. Call 1.800.TECTRUE or 1.847.803.5000 Option 1 for installation or other technical assistance.

