

## EZ FILL™ FAUCET

AUTOMATIC  
DECK MOUNTED FAUCET  
INSTALLATION AND MAINTENANCE GUIDE

# TABLE OF CONTENTS

2	PRE-INSTALLATION INFORMATION
3	PACK CONTENTS
4	TECHNICAL DATA
5-7	INSTALLATION
8-9	SETTINGS ADJUSTMENT
10	BATTERY REPLACEMENT INSTRUCTIONS
11	SPARE PARTS LIST
11	MAINTENANCE
12	WARRANTY
13	TROUBLESHOOTING

Unit Install Date \_\_\_\_\_  
Unit Location in Facility \_\_\_\_\_  
Unit S/N (From Label) \_\_\_\_\_  
Supplied By \_\_\_\_\_  
Original PO No. \_\_\_\_\_  
ASI Order No. \_\_\_\_\_

# PRE-INSTALLATION INFORMATION

## CHECK CONTENTS

Separate all parts from the packaging and check each part with the "Pack contents" section. Pay attention to the different models variations.

Make sure all parts are accounted for before discarding any packaging material. If any parts are missing, do not attempt to install your electronic faucet until you obtain the missing parts.

## WARNINGS

Do not install facing a mirror or any other electronic system operated by an infrared sensor. To prevent reflection problems, it is recommended to keep a minimum distance of 1.50 meters between the faucet and any other objects.

## PREPARATION FOR INSTALLATION

Flush water supply lines thoroughly before installing the faucet. Do not allow dirt, Teflon tape or metal particles to enter the faucet.

Shut off water supply.

Installations in Australia and New Zealand must comply with the requirements of AS/NZS 3500.

Important: All plumbing is to be installed in accordance with applicable codes and regulations.

## RECOMMENDED HOLE SIZE

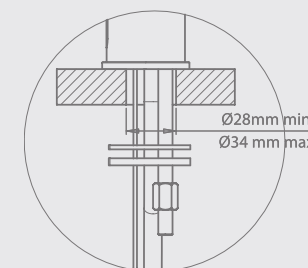

Familiarize yourself with the part names and confirm that the parts are included.



1 X FAUCET AND ATTACHMENTS



1 X FILTER



1 X ALLEN KEY

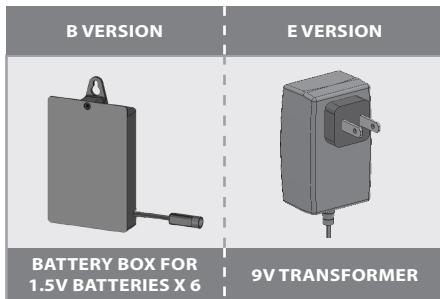

Batteries not included

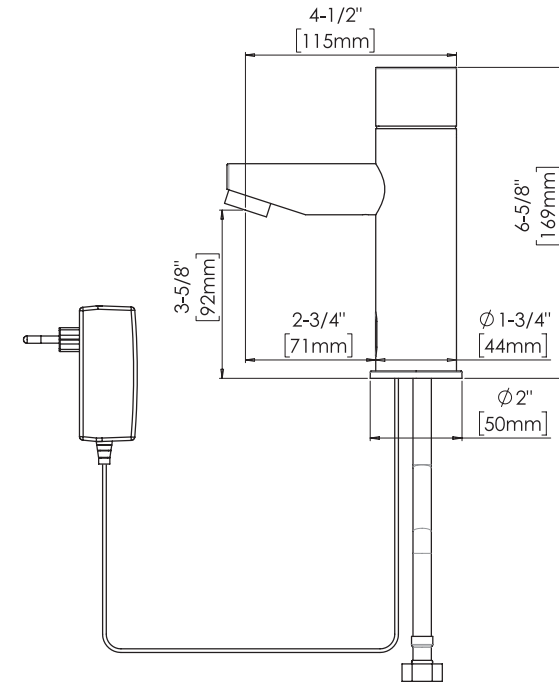
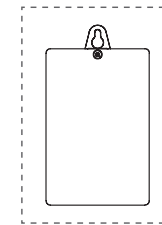

EZFILL™ FAUCET (battery powered) - 235100  
EZFILL™ FAUCET (transformer powered) - 235200

<b>Power supply:</b>	6 X 1.5V AA batteries or 9V transformer
<b>Recommended water pressure:</b>	8.0-0.5 bar (116-7 PSI) With water pressure of more than 8 bars, use a pressure reducing valve for reduction.
<b>Preset sensor range:</b>	200mm / 7.87" (customizable with optional remote control)
<b>Minimum sensor range:</b>	35mm / 1.38"
<b>Maximum sensor range:</b>	300mm / 11.81"
<b>Security time:</b>	90 seconds (can be reduced with optional remote control)
<b>Hot water temperature:</b>	Max 70 °C

# INSTALLATION

## STEP 1 – PREPARATION FOR MOUNTING THE FAUCET

1 Shut off the water supply.

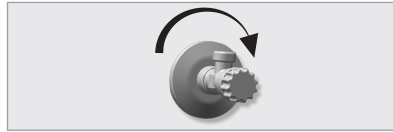

2 Remove the hexagonal nut, the disk and the gasket. Do not remove the O-ring from the base of the faucet.

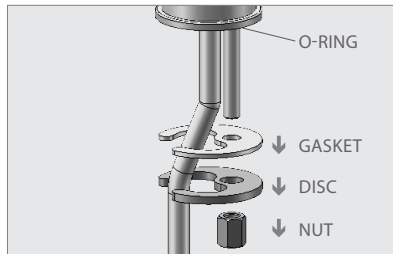

## STEP 2 – INSTALLING THE FAUCET

1 Place the faucet with O-ring into the hole in deck or lavatory. Make sure the O-ring is located between the deck or lavatory and the bottom of the faucet.

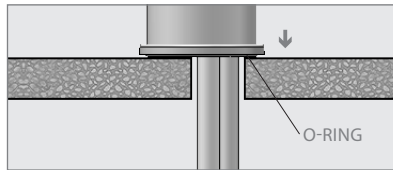

2 Slide the gasket, disk and hexagonal nut over the flexible hose and secure the faucet into place.

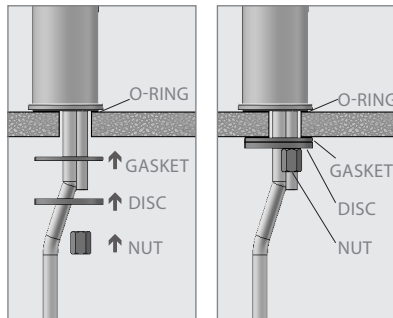

# INSTALLATION

## STEP 3 – CONNECTING THE WATER SUPPLY

1 Connect the flexible pipe to the water supply.  
*For models with temperature control connect the red flexible pipe to the hot water supply and the blue flexible pipe to the cold water supply.*

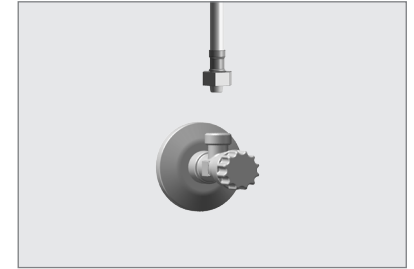

MAKE SURE THAT THE FILTER(S) IS/ARE INSTALLED BETWEEN THE FLEXIBLE PIPE AND THE SHUT OFF VALVE (ANGLE VALVE) (NOT SUPPLIED).

2 Turn on the central water supply and the shut-off valves (angle valves) and check for leaks.

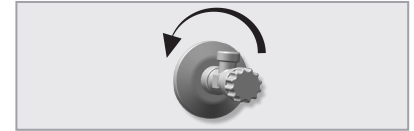

## STEP 4 – CONNECTING THE POWER SOURCE

### BATTERY VERSION

Install the battery box at the wall underneath the sink using the two sided adhesive foam tape. The cable connection must point down. (You can use an optional extension cable in order to assemble the battery box up to 10ft. away from the sink.)

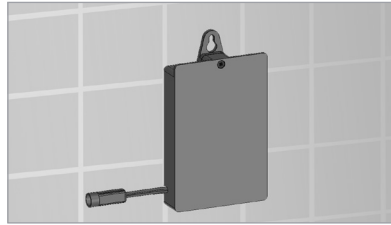

1

### TRANSFORMER VERSION

Plug the transformer into the electricity socket and connect the connectors.



2

In order to avoid entering into the adjusting mode, wait 10 seconds before operating the faucet. If the range is unsatisfactory, refer to the section titled "settings adjustment."



### Adjusting the settings with the remote control

If necessary, the sensor settings can be adjusted as following: Shut off the water supply. In order to adjust the sensor with the remote control, hold the remote control straight in front of the sensor in a distance of about 20-15) "8-6cm). Choose the function you want to adjust by pressing once on one of the function buttons. After pressing once on a specific function button, a quick flashing of the LED at the front of the sensor will occur. At this stage, you can change the setting by pressing the (+) or the (-) buttons, every push will increase or decrease one level. After finishing the adjustment, turn the water supply back on.



**DETECTION RANGE:** Only if necessary, use the remote control to adjust the sensor range as follows:

Press the RANGE button. Wait until a quick flashing of the LED in the sensor eye is perceived. Then, press + to increase the one level and - to reduce it every push will increase or decrease one level.

**NOTE:** Once you have changed the detection range with the remote control, this distance will be remembered by the sensor, even if the power source is disconnected.



## SPARE PARTS LIST

Seals and Screws Kit	-)44,
10-pack Sensor Kit	10-0397-S
Cover Kit	-)☒
10-pack Solenoid Valve Kit	10-0397-VK
Battery box with 6X1.5V AA batteries	10-0397-BP
Transformer	-)☒
Remote Control 13B (Optional)	07100005
Soap & Water Remote Control (Optional)	10-0390-R-MASTER

## MAINTENANCE

### Filter cleaning instructions

This faucet is provided with one / two stainless steel filter(s) preventing foreign particles to enter the lines. If the water flow has decreased, this can be because the filter(s) is/are clogged. The filter(s) can be cleaned as follows:

1. Shut-off the water shut off valve (angle valve).
2. Disconnect the flexible pipe/s.
3. Remove the filter(s) and wash it/them under running water.
4. Reassemble the parts.
5. Make sure that there is no water leakage.

### Care and cleaning of chrome and special finishes

**DO NOT** use steel wool or cleansing agents containing alcohol, acid, abrasives, or the like. Use of any prohibited cleaning or maintenance products or substances could damage the surface of the faucet. For surface cleaning of faucet use **ONLY** soap and water, then wipe dry with clean cloth or towel. When cleaning bathroom tile, the faucets should be protected from any splattering of harsh cleansers.

## WARRANTY

We are pleased to offer this warranty covering ASI products furnished for your project.

This warranty replaces any other warranties or product descriptions, whether expressed or implied, written or oral.

It is understood that the products for this project have been selected and inspected by the purchaser, and have been accepted without qualification by the purchaser as merchantable, fit for the intended use, and satisfy the specifications.

**EZ FILL™ SOAP DISPENSER PRODUCTS WILL BE FREE OF DEFECTS IN MATERIAL AND WORKMANSHIP DURING NORMAL USE FOR (2) TWO YEARS FROM THE DATE OF INVOICE.**

Should the product fail under this warranty, the sole remedy, at the seller's option, will be to repair the defective product, refund the purchase price, provide an equivalent new or refurbished product or provide parts only.

ASI AND/OR SELLER DISCLAIM ANY LIABILITY FOR SPECIAL, INCIDENTAL OR CONSEQUENTIAL DAMAGES. This warranty excludes product damage due to incorrect installation, improper maintenance, wear and tear, battery spoilage, product abuse, or product misuse, whether performed by a contractor, service company, or the consumer.

ASI will not be responsible for labor costs associated with the removal, replacement, repair by others, reinstallation, renovation or return of its products.

# TROUBLESHOOTING

PROBLEM	INDICATOR	CAUSE	SOLUTION
No water coming out of the faucet:	1. Sensor flashes continuously when user's hands are within the sensor's range.	Low battery.	Replace battery
	2. LED in the sensor does not flash once when user's hands are within the sensor's range.	1. Range is too short.	Increase the range
		2. Range is too long.	Decrease the range
		3. Battery is completely used up	The battery must be replaced.
	3. LED in the sensor flashes once when user's hands are within the sensor's range.	4. Unit is in "Security Mode" <sup>**</sup>	Eliminate cause of reflection.
5. Sensor is picking up reflections from the washbasin or another object.			
1. Connectors between the electronic unit and solenoid are disconnected.		Connect the electronic unit connectors to the solenoid.	
2. Debris or scale in solenoid.		Unscrew solenoid, pull out the plunger and the spring from the solenoid and clean them. Use scale remover material if needed. When replacing the plunger, please make sure that the spring is in vertical position.	
		3. The central orifice in the diaphragm is plugged or the diaphragm is torn	Clean the orifice or replace diaphragm.
4. The water supply pressure is higher than 8 bar.	Reduce the supply water pressure.		
Water flow from spout does not stop:	1. Sensor flashes once when user's hands are within the sensor's range.	Debris or scale in diaphragm	Clean the orifice or replace diaphragm.
	2. LED in the sensor does not flash once when user's hands are within the sensor's range.		
Water flow diminished	1. Sensor is dirty or covered.**	Filter or aerator is clogged	Remove, clean, re-install
	2. Sensor is picking up reflections from the washbasin or another object.		

\* "Security Mode": If the sensor is covered for more than 90 sec. the faucet will automatically shut off water flow. To return to normal operation remove any blockage.

\*\* In this case, the water flow will stop anyway after 90 seconds because of the security time.



# ASI<sup>®</sup>

