



S19224PDC, S19224DC, S19224DCPT

Wall-Mount Halo™ Eyewash with Bowl Dust Cover

- Halo™ Delivers the Most Effective Eye/Face Washdown Coverage and Spray Pattern
- Exceeds ANSI/ISEA Z358.1 Specifications
- Exceeds European EN 15154-2
- Industry's Only Self-Draining Design – The Aquaduct™
- Separate Supply and Waste Pipes – Meets CEN and Plumbing Requirements
- Ergonomic Hand Activation Eyewash Paddle – Easy to Reach from Any Direction
- Barrier Free
- Fully-Assembled and Factory-Tested Eyewash with Hinged Dust Covers
- Yellow Transparent Plastic and Stainless Steel Bowl Covers Available
- Universal Identification Sign and Inspection Tag Included
- Classified by Underwriters Laboratories Inc. to ANSI/ISEA Z358.1.
- Halo is Covered by One or More of the Following Patents: 9,700,484; 9,314,398; D662220; D673298; D662605; D685920; D662219; and D671228. Other Patents Pending.

Specifications

Standard Eyewash Units save space and fit easily into any work environment. Halo eyewash, operated by an ergonomic, highly visible push handle, provides effective wash down coverage and spray pattern. Integral strainer reduces debris in the water and also prevents clogging.

This plumbing fixture is not intended to dispense water for human consumption through drinking or for preparation of food or beverages.

Pipe and Fittings

Piping to ½" NPT water supply inlet on unit. Piping to 1¼" NPT drain outlet for eyewash. 1¼" piping assembly manufactured of one of the following materials:

- Galvanized steel with BradTect® safety yellow coating

Ball Valve

½" stay-open eye and eye/face wash valve manufactured of the following materials:

- Chrome-plated brass

Eyewash

The Halo eyewash system offers a high performance rinsing platform that provides rapid relief to an individual's eyes that have been injured by chemicals or particulate. The eyewash includes an integral 5.1 GPM (19.2 L) flow control, providing water at a safe velocity while maintaining its effectiveness (exceeds minimum water flow of 0.4 GPM (1.5 L) at 30 PSI (2.0 bar)). Eyewash is protected by flip open dust covers that open when product is activated or by a full bowl dust cover that activates the unit when it is opened. Safe, steady water flow under varying water supply conditions from 30–90 PSI (2.0–6.1 bar) is assured by integral flow control in the sprayhead assembly. Sprayheads are made from an impact resistant ABS plastic.

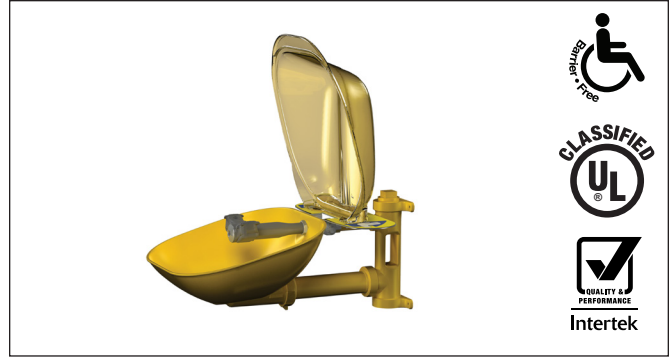

Activation

Type 304 stainless steel push handle.

Bowl

Bowl is constructed of yellow impact-resistant plastic (S19224PDC) or Type 304 corrosion resistant stainless steel (S19224DC, S19224DCPT).

Bowl Dust Cover

Dust cover is constructed of yellow impact-resistant plastic (S19224PDC) or Type 304 corrosion resistant stainless steel (S19224DC, S19224DCPT).

Wall Bracket

Heavy-gauge sand cast aluminum protected with BradTect safety yellow coating. Includes three clearance holes for mounting bracket onto wall (mounting hardware not included).

Waste

1¼" drain fitting and tailpiece furnished. Chrome-plated p-trap included with S19224DCPT.

Model	Description
<input type="checkbox"/> S19224PDC	Halo eyewash, plastic bowl w/ dust cover
<input type="checkbox"/> S19224DC	Halo eyewash, stainless steel bowl & hinged dust cover
<input type="checkbox"/> S19224DCPT	Halo eyewash, stainless steel bowl & hinged dust cover, p-trap

Tepid Water Options

[Navigator S19-2000 EFX8
Emergency Thermostatic Mixing Valve](#)

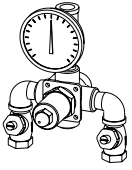

[Keltech CLE-Series
Tankless Water Heater](#)

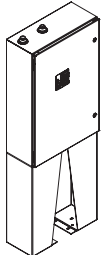

Satisfies ANSI/ISEA Z358.1 tepid water requirements.



S19224PDC, S19224DC, S19224DCPT

Wall-Mount Halo™ Eyewash with Bowl Dust Cover

S19224 shown with Eyewash and Bowl Dust Cover

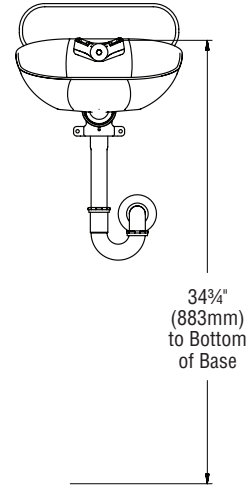
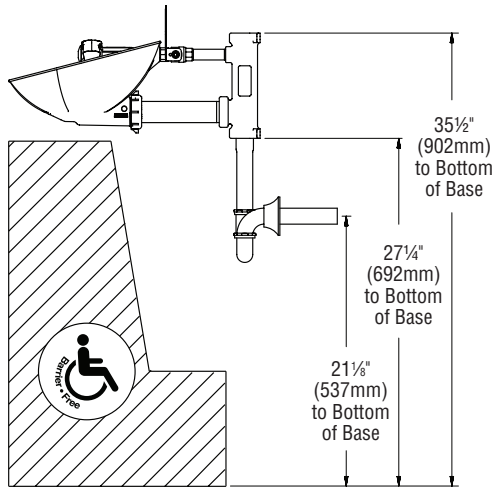

Eyewash Bowl

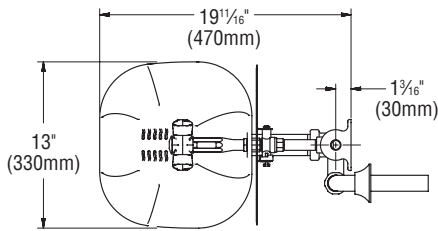

Dust Cover

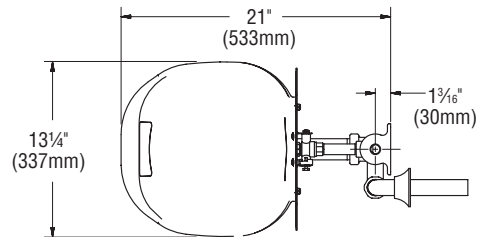

 All dimensions assume standard thread engagement. Variations in manufacturing allow for +/- 1/8" (3mm) per threaded joint. To find the tolerance of a dimension, add the number of thread joints across the length of the dimension and multiply it by 1/8" (3mm).